

# ASSARAIN CONCRETE PRODUCTS

*Blending Trust with Quality....*

*High Quality hydraulically pressed*

## **KERBSTONES & PAVING SLABS**



Through the history of Assarain Concrete Products & Trading LLC (ACP), high quality Kerbstones and Paving Slabs produced by ACP have been widely accepted by the Consultants, Contracting companies and Government organizations for all prestigious infrastructure projects. ACP utilizes the latest state of the art, technologically advanced, large "hydraulic pressing" plants to produce such dense, durable well finished Paving Slabs and Kerbstones. The hallmark of ACP is the availability of the entire fast moving range of products required for any kind of infrastructure project conceived in Sultanate of Oman. The range consists of Paving Slabs in different sizes and thickness, Kerbstones in various sizes, thickness and lengths apart from also special decorative Kerbstones. The Kerbstones are available in smooth finish as well as in "pimpled" finish and ACP is known for always carrying right stocks of fast moving items for timely deliveries.

Many large prestigious and fast track projects are known to have used ACP Kerbstones, Paving Slabs and Roof Slabs.

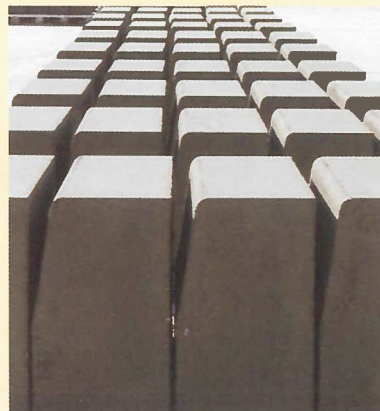



# Dense and durable Kerbstones

## Multiple types and sizes

High quality Kerbstones produced by ACP helps in providing protection, guard, safety and strength to roads and infrastructure projects. To provide multiple options to the Consultants, Contracting Companies and Government organizations, following tailormade range is available in Kerbstones :-

### Non Mountable / Half Battered Series

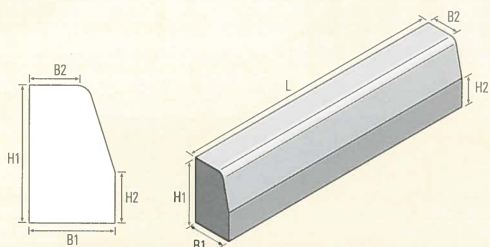

Dimensions in mm					
B1	B2	H1	H2	L	
125	85	255	155	914	
150	-	255		914	
150	115	305	200	914	
150	100	350	150	600	LIP KERB
150	110	350	150	600	OMANI
150	110	350	200	600	CONCERT
150	105	300	150	600	
200	110	350	150	600	
200	140	380	210	600	
200	155	300	150	600	

### Bull Nose Series

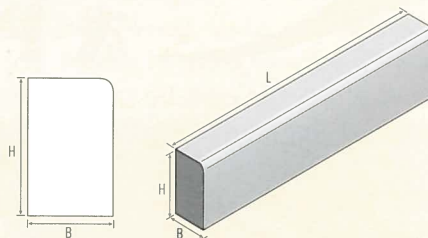

Dimensions in mm								
L	B	OR	B	OR	B	OR	B	H
914	50		75		100		125	150
914	50		75		100		125	150
914	50		75		100		125	150
914	50		75		100		125	150
914	50		75		100		125	150
914	50		75		100		125	150
600	150		-		-		-	350

### Mountable / Full Battered Series

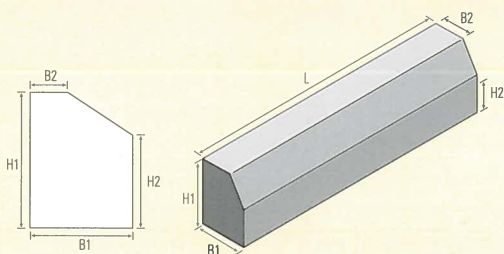

Dimensions in mm				
B1	B2	H1	H2	L
200	50	350	250	600
125	50	255	180	914

### Rectangular Series

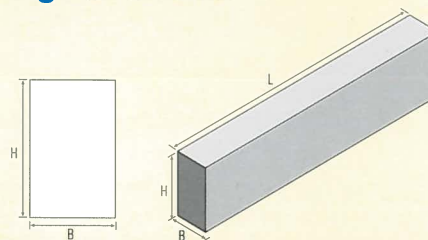

Dimensions in mm								
L	B	OR	B	OR	B	OR	B	H
914	50		75		100		125	150
914	50		75		100		125	150
914	50		75		100		125	150
914	50		75		100		125	150
914	50		75		100		125	150
914	50		75		100		125	150

## Decorative Kerbstone Range

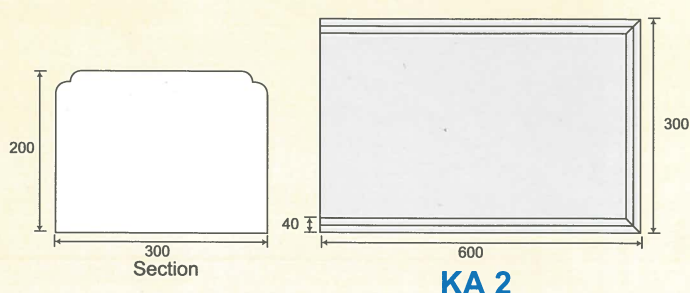
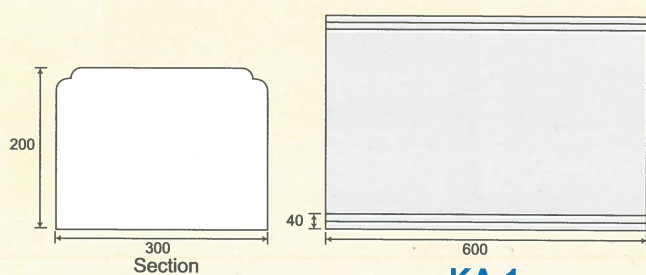

# Decorative Kerbstone Range

## Specifications

Kerbs	: BS 7263-3	: 2001
	: BSEN 1340	: 2003
Paving Slabs	: BS 7263-1	: 2001
	: BSEN 1339	: 2003

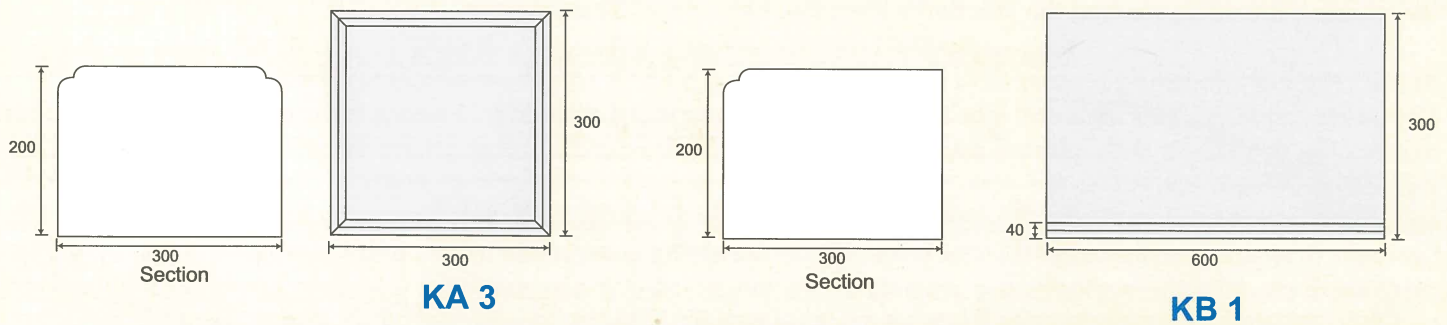

## Traffic Barrier Kerb

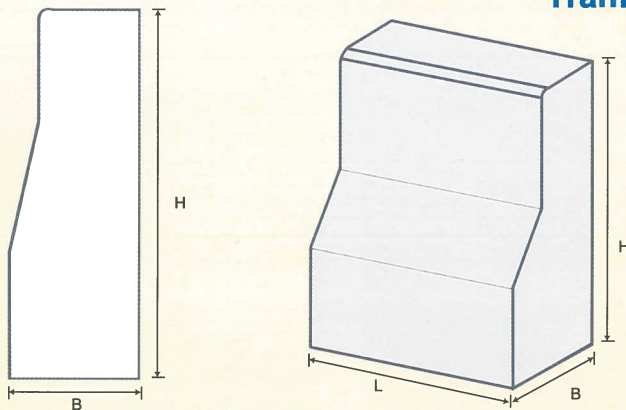

### Dimensions in mm

L	B	H
450	200	600

## Hydraulically pressed paving slabs Multiple range of colours and sizes

As part of our endeavour to bring new designs, ACP offers various colours, sizes and textures of Paving Slabs helping pavements and walkways to look aesthetically beautiful. ACP Paving Slabs are highly dense, hydraulically pressed with low water absorption, provide durable pavements and even industrial floors. The Paving Slabs are produced in various basic colours to provide appealing designs through these large paving elements. Paving Slabs are simple to lay, cost efficient and help in quick laying of pavement. The concrete Paving Slabs are available in the following main ranges :-

### Chamfered Slabs

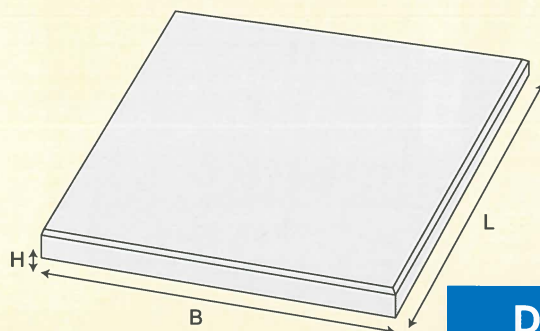

### Plain Slabs

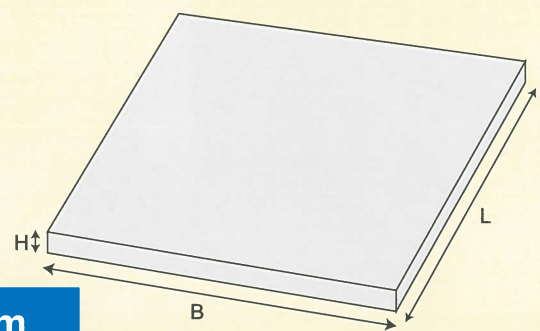

### Dimensions in mm

L	B	H
400	400	40
400	400	50
500	500	50
600	600	50



## Manufacturing process of Kerbstones and Paving Slabs :-

As per Oman Standards, Kerbstones and Paving Slabs are to be specifically hydraulically pressed rather than vibro-compacted on pallets. This is because hydraulically pressed Kerbstones and Paving Slabs are much more dense, have very low interstitial spaces and are not open to leaching even in adverse environment. These are specifically suited for regions flanked by sea and the standards therefore helps save the pavements.

At ACP, the manufacturing process of Kerbstones and Paving Slabs is compliant with the various specifications and are also tailor-made, suiting different specific applications and market segments. Various high quality coarse and fine aggregates are mixed with plaster sand and dosed in the automatic mixer in pre-determined proportions. The thoroughly mixed wet-mix is fed into moulds through automatic volumetric dispensers, adjustable to dispensing aggregate quantity of concrete for producing various sizes of Kerbstones and Paving Slabs through moulds. The hydraulic pressure of more than 400 tons is applied on the mould concrete by means of a Die which is mounted on the machine ramp. After the high pressure pressing on the mould table, the excess water is taken out, dense product made and then the Kerbstones and Paving Slabs are ejected automatically, thereafter palletized and cured. ACP lays great emphasis on proper curing, inspection, quality control checks and thereafter, these high quality products are ready for dispatch. These are in line with the quality control procedures as per ISO 9001, ISO 14001 and OHSAS 18001 Integrated Quality Management Systems.



Only quality inorganic colour pigments and natural aggregates are used. Minor variation in colour and texture may occur. This is normal and does not constitute reason for complaint.



Blending Trust  with Quality....

# Assarain Concrete Products & Trading L.L.C.

(A member of the Assarain Group)

PO Box 971, C.P.O Seeb, PC 111, Sultanate of Oman. Sales Showroom: Madinat Sultan Qaboos, Tel: 24605986, 24694321 Fax: 24695957  
Tel: (Factory) 24437636 / 24437356 Fax: 24437175 - Despatch: 24437717 / 99437504 E-mail: acpllc@omantel.net.om

An ISO 9001:2008, ISO 14001:2004 & OHSAS 18001:2007 certified Company

